

PLANTA REGISTRO CON FONDO

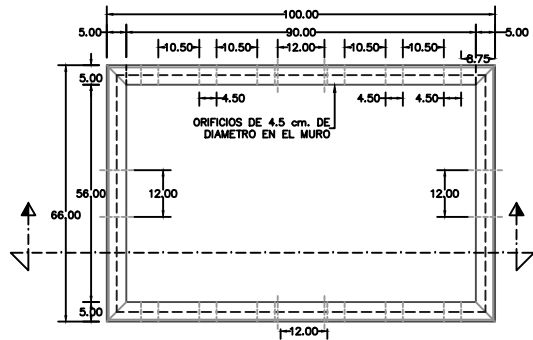

PLANTA REGISTRO SIN FONDO

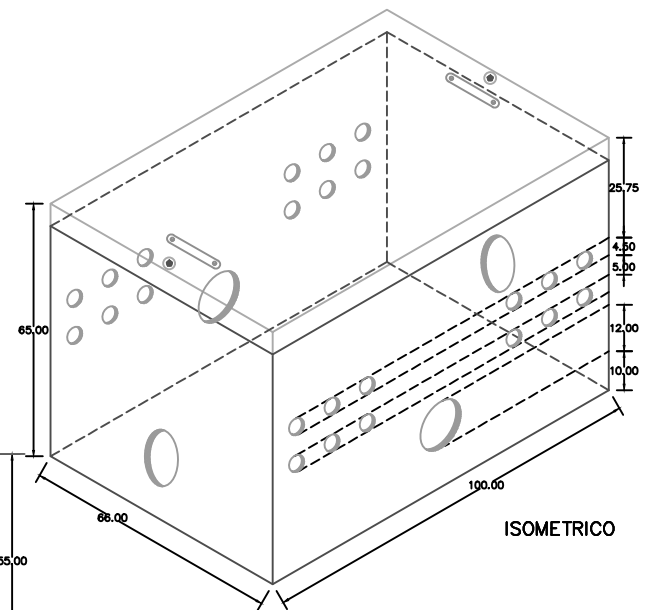

ISOMETRICO

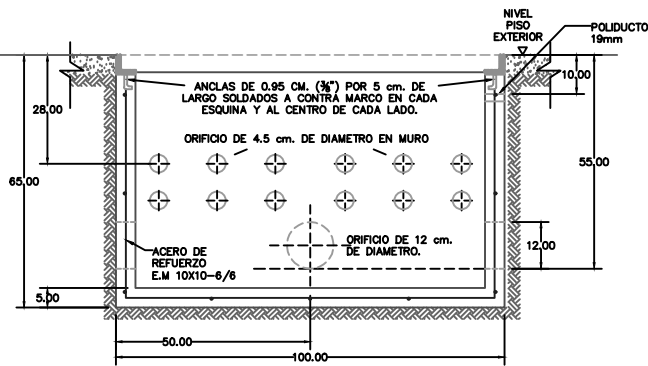

CORTE A-A'

REGISTRO CON FONDO PARA NIVEL FREATICO ALTO

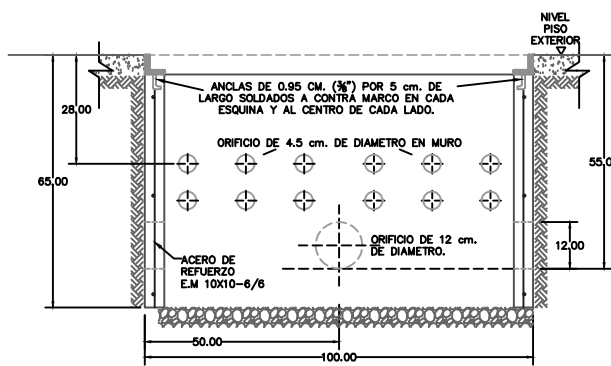

CORTE A-A'

REGISTRO SIN FONDO PARA NIVEL FREATICO BAJO

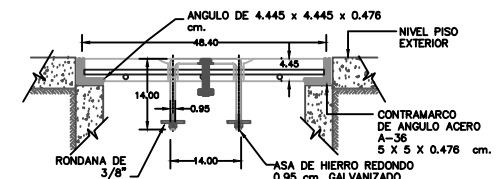

DETALLE TAPA: CORTE D-D'

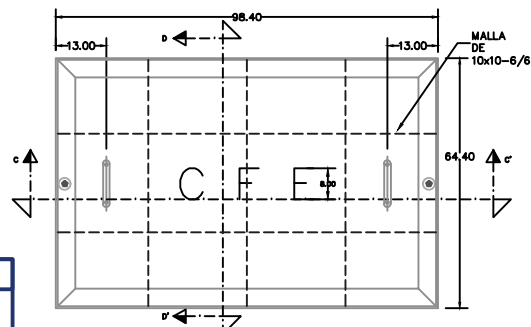

PLANTA TAPA

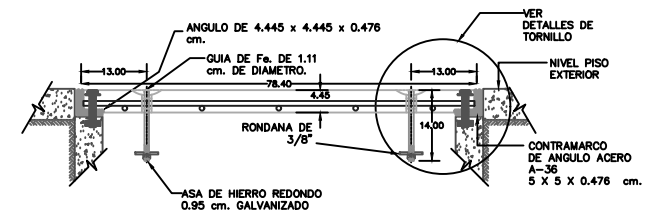

DETALLE TAPA: CORTE C-C'

NORMA CFE-RBTB2

REGISTRO DE BAJA TENSION EN BANQUETA TIPO 2

